

Chevet mural Floating nightstand

Suzon

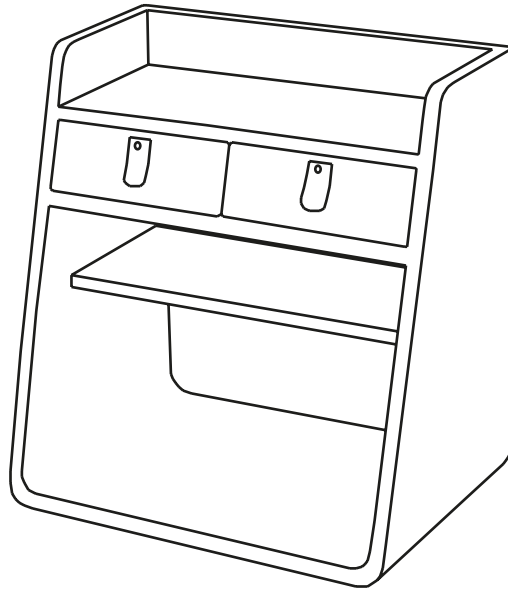

Design by Florence Watine



DANS VOTRE COLIS IN YOUR PACKAGE

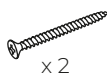
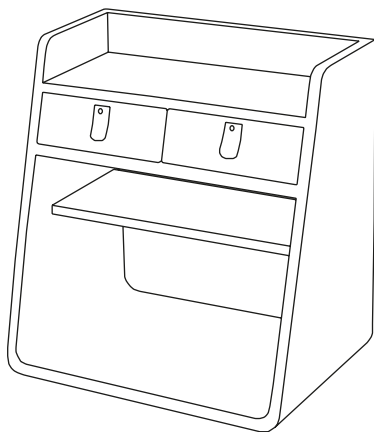

MATÉRIEL REQUIS REQUIRED TOOLS

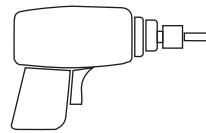

Perceuse - Visseuse
Drill - Screwer

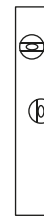

Niveau à bulle
Spirit level



Crayon
Pencil



Chevilles
Wall plugs
x 2

À ASSEMBLER SEUL ASSEMBLE ON YOUR OWN



x1

Une question ? Contactez-nous grâce au formulaire dédié sur notre site !
Have a question? Please contact us using the dedicated form on our website!

 www.hartodesign.com



FR
Donnez ou recyclez vos meubles.



Association



Magasin



Déchèterie

<https://quefairedemesdechets.fr>

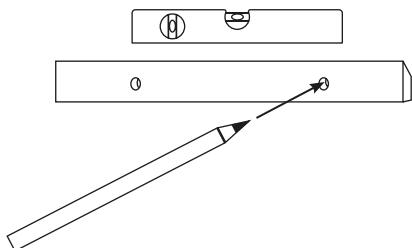

①

Positionner le tasseau horizontalement sur votre mur à l'aide du niveau à bulle à la hauteur voulue, puis marquer l'emplacement des trous à l'aide du crayon.

Place the cleat horizontally on your wall at the desired height using the spirit level, then mark the location of the holes with the pencil.

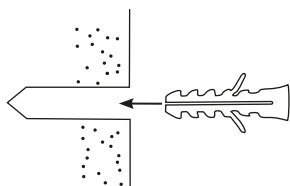

②

Percer le mur aux emplacements marqués. Insérer les chevilles adaptées au type de mur.

Drill the wall at the marked places. Insert the wall plugs best suited to the wall.

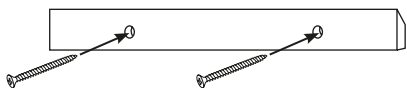

③

Fixer le tasseau au mur avec les vis.

Fix the cleat to the wall with the screws.

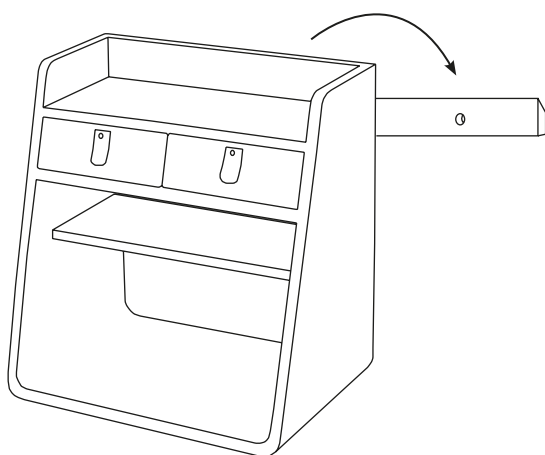

④

Suspendre le chevet sur le tasseau.

Hang the floating nightstand on the cleat.