

Bureau Desk Victor

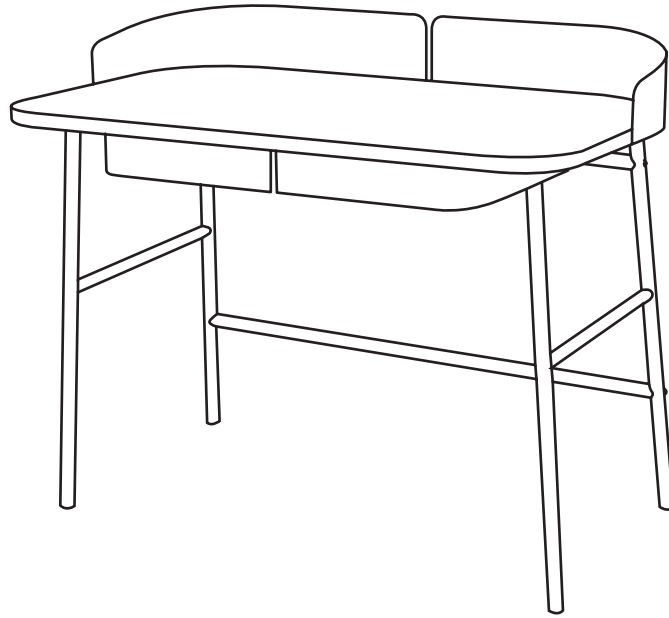

Design by Pierre-François Dubois



DANS VOTRE COLIS IN YOUR PACKAGE

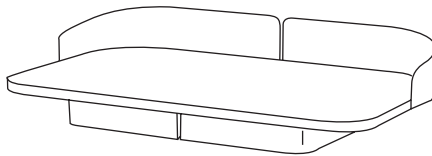

A



B

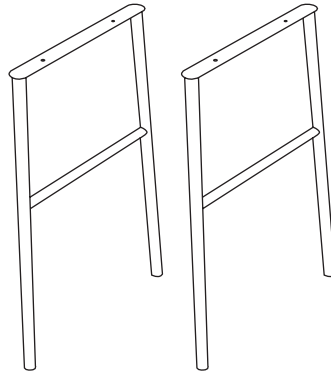

x 6



x 4



Clé Allen
Allen key

MATÉRIEL REQUIS REQUIRED TOOLS

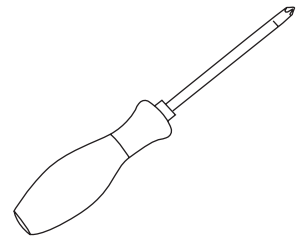

Tournevis
Screwdriver

À ASSEMBLER SEUL ASSEMBLE ON YOUR OWN



x1

Une question ? Contactez-nous grâce
au formulaire dédié sur notre site !
Have a question? Please contact us using
the dedicated form on our website!

 www.hartodesign.com



FR
Donnez ou recyclez
vos meubles.



Association



Magasin



Déchèterie

<https://quefairedemesdechets.fr>

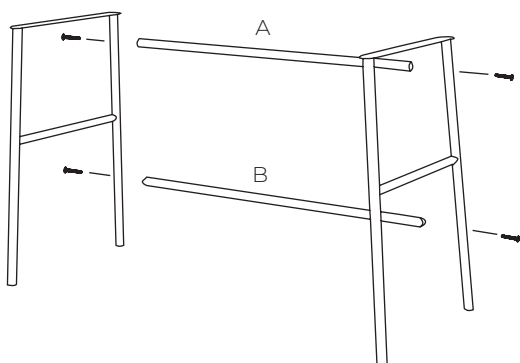

①

Avec les 4 grandes vis et la clé Allen, prévisser la tige horizontale haute (A) aux deux pieds. Prévisser la tige horizontale basse (B) aux deux pieds.

Use the Allen key and the 4 large screws, attach the upper horizontal rod (A) to both feet. Attach the lower horizontal rod (B) to both feet.

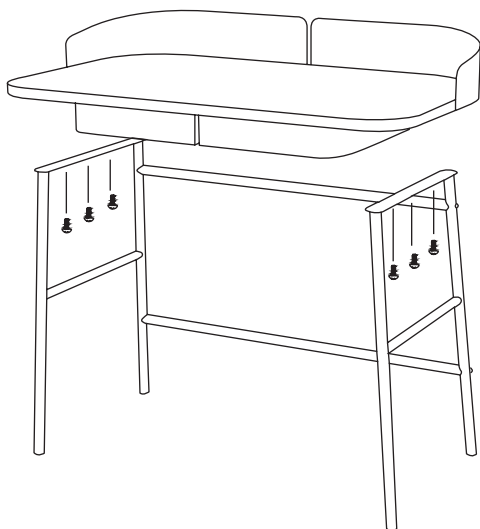

②

Visser le plateau aux pieds à l'aide des 6 petites vis et d'un tournevis cruciforme.

Screw the tabletop to the legs using the 6 small screws and a crosshead screwdriver.

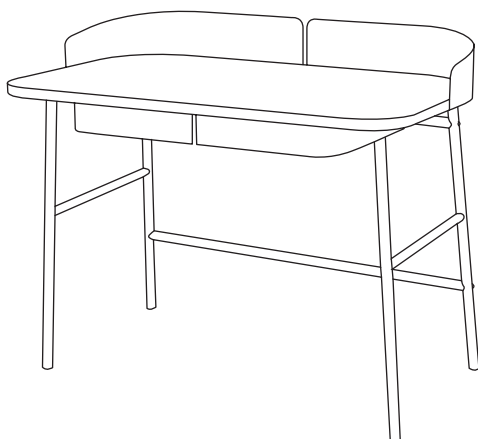

③

Une fois le plateau fixé, finaliser le serrage du piétement à l'aide de la clé Allen.

Once the tabletop is fixed, finalise the tightening of the base with the Allen key.